

Kommander R12

LED Receive series

Version: Ver:B1.0

Release date: February 2023



Specifications



TEL 400 159 0808

Web: www.kystar.com.cn

Beijing KYSTAR Technology Co., Ltd.

Professional Ultra HD Video Display
Control system integrated solution and service provider

Version record

version number	change details	release time
Ver: B1.0	first edition released	2023.02.14

overview

Kommander Gold Card Series R12 receiving card is an important part of the main control system of the LED large screen. control system. It adopts the industry's top design technology and complies with international and industry standards.

Gold card receiving card R12's unique color transformation technology makes the skin color of the face more realistic; the unique arbitrary frequency multiplication technology makes mobile phone shooting without scanning lines.

Features

- There are 12 standard interfaces with 18 bit encryption processing on a single card, outputting 24 sets of RGB data.
- The maximum load of a single card is 128×768, and the maximum load of 512×320 supports correction data.
- Support a variety of general-purpose chips, PWM chips, and double-latch chips.
- Unique arbitrary frequency multiplication technology, mobile phone shooting without scanning lines.
- The unique color transformation technology makes the skin color of the human face more realistic.
- Support high gray, high brush, low brightness and high gray scale display.
- The details are processed perfectly, which can eliminate problems such as darkening of a certain line, reddish low gray, ghosting, etc.
- Support point-by-point correction of brightness and chroma, provide low gray compensation for correction, and ensure low gray effect.
- Support one-key read back configuration file information function.
- Support one-key repair function,
- Support real-time detection of network communication status and detection of network cable connection sequence.
- It supports random sampling, and can easily set up various special-shaped screens.
- The program is write-protected, so you don't have to worry about power failure when upgrading.

Panel description

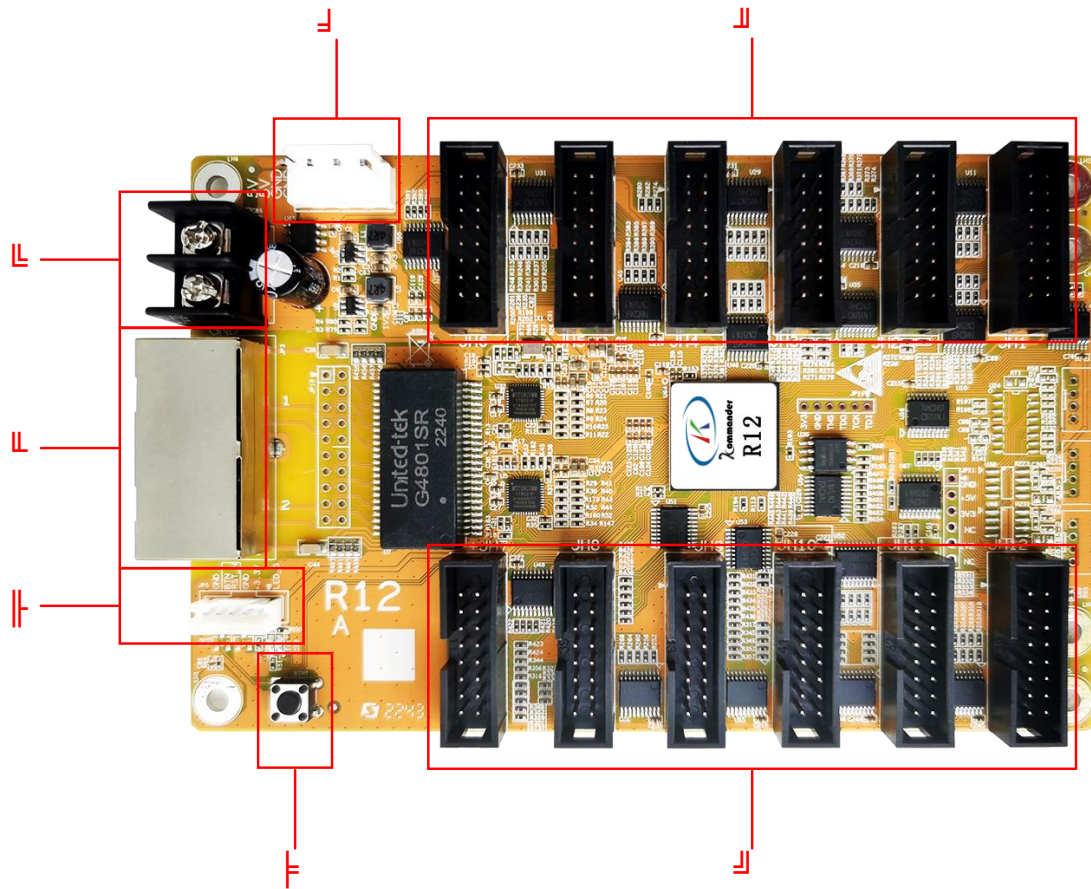

serial number	Function Description
①	Two Gigabit Ethernet ports, no distinction between input and output
②	Terminal block provides 5V voltage, 5V and GND
③	4P straight plug connector, providing 5V voltage, 5V and GND
④	16P cable ports JH1 to JH6 (from right to left)
⑤	16P cable ports JH7 to JH12 (from left to right)
⑥	LED signal status indicator, test button
⑦	JP5, connected to the LCD color screen to display the running status of the receiving card

Port specification

The twelve 16P (JH1-JH12) ports of the output ports are defined as follows: JH1-JH12								
Pin	1	3	5	7	9	11	13	15
Definition	R1	B1	R2	B2	A	C	CLK	OE
Pin	2	4	6	8	10	12	14	16
Definition	G1	GND	G2	E	B	D	LAT	GND

Note: The E signal can be used as the blanking control pin when the screen scan is less than 16 scans, and it can be used as the E signal when the screen scan is greater than 16 scans.

JP5 port definition					
Pin	1	2	3	4	5
Definition	STA_LED	LED+ / +3.3V	PWR_LED-	KEY+	KEY-/GND

Indicator light status	
LED1	The power indicator is red, always on means the power supply is normal, and off means there is no power
LED2	The device running indicator is green, flashes when there is a signal input, and is off or always on when there is no signal

Machine specification	
input power	3.5-6V 0.6-1A
Operating temperature	-10°C - 70°C
Working humidity(%)	0%-95%
Supported screen types	Full Color Real Pixel
Single network cable cascade receiving	<200
Single receiving card carrying pixel area	128*768
The number of RGB data groups output	24
Working current	0.6A - 1.0A
Limit working temperature	-20°C - 75°C

Attachment: equipment size chart

Unit mm

